

## Features

- High efficiency Multi/Mono crystalline cells
- High quality EVA & back sheet to ensure high performance and provide good weather \ resistance for rugged environments.
- Anodized aluminum alloy frame and tempered & textured clear glass with low iron content to enhance high efficiency.
- Bypass diodes provided to avoid effect of partial shading.
- IEC61215, IEC61730 & IEC61701 certified
- An ISO 9001:2015 & ISO14001:2015 certified production facility.
- PV module power rating from 3wp to 300wp
- 25 years limited warranty on power output. Output will be still 80% in 25 years, based on rated module performance less the negative tolerance.

Electrical Specifications:	
Product Description	SS-40(12V)
Rated Power Pmax - [W]	40
Rated Voltage Vmax - [V]	18.00
Rated Current Imax - [A]	2.23
Open Circuit Voltage Voc - [V]	22.00
Short Circuit Current Isc - [A]	3.40
Tolerance	±3%
Standard Test Conditions: Irradiance 1000 W/ m <sup>2</sup> , Module temperature 25°C, Spectrum AM 1.5	

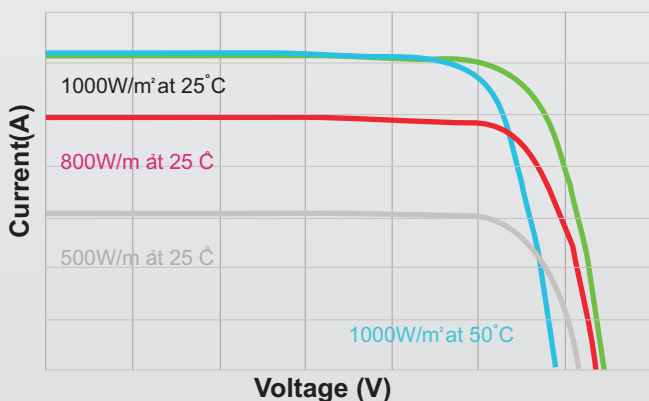

Current voltage dependence on Irradiance and module temperature. this is only indicative showing affect of temperature and intensity on power

### Temperature Coefficients

Voltage Voc : ( - 0.379% of Voc / K)  
Current Isc : ( - 0.0396% of Isc / K)  
Power Pmax : ( - 0.48%/deg K)

Maximum system voltage : 1000VDC  
Operating Module Temperature : - 40°C to +90°C  
NOCT : 47°C ± 2°C

### Certifications



SIRIUS SOLAR ENERGY SYSTEMS Pvt.Ltd.

Regd.Office : H.No.:3-6-35/14, Plot No.:454, Vivekananda Nagar, Kukatpally, Hyd - 072

Phone: +91-40 - 23065133, Fax No: +91-40-23064121, Cell:+91-9705922256

Email : marketing@siriussolarenergy.com, Web Site: www.siriussolarenergy.com



**Module Drawing & Mounting details:**

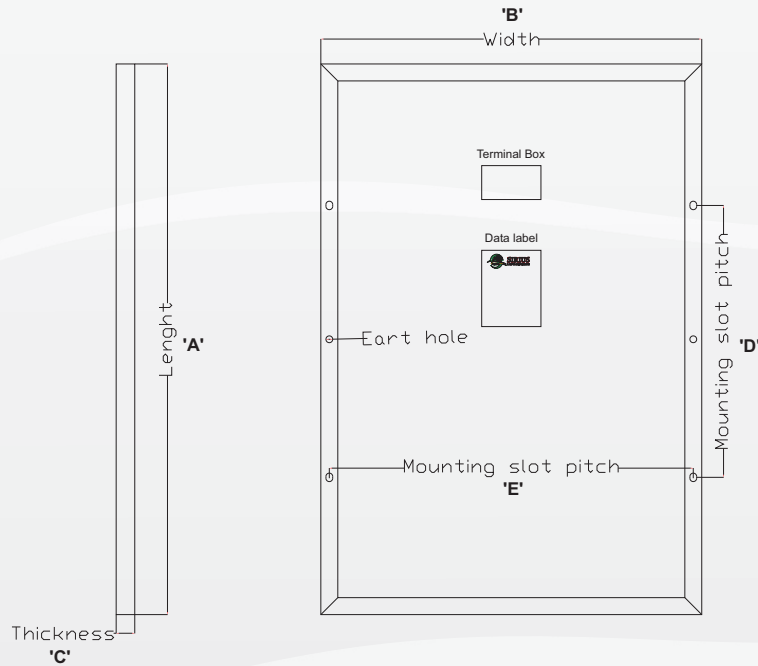

<b>Mechanical Specifications:</b>	<b>SS-40(12V)</b>
Length [mm] - A	656 ± 1
Width [mm] - B	434 ± 1
Thickness [mm] - C	34 ± 1
Mounting slot [mm] - D	400 mm
Mounting slot [mm] - E	390 mm
Mounting hole (mm)	6X9 mm
Earth hole	4mm dia
Aprox. weight [Kg]	3.50
No. of cells & Arrangement	36 (4x9)

<b>Other Characteristics:</b>	
Cell type	High Efficiency Multi/Mono Crystalline Cells (156 mm X 156 mm )
Front Glass	Toughened Textured Glass
Glass thickness	3.2 mm
Cell Encapsulation	EVA (Ethylene Vinyl Acetate)
Back sheet	Poly vinyl Fluoride
Frame	Silver Anodized Aluminum Alloy
Junction Box	3 rail junction box
No.of Diodes	2

specifications are subject to change without prior notice due to constant improvement in design & technology

SIRIUS SOLAR ENERGY SYSTEMS Pvt.Ltd.

Regd.Office : H.No.:3-6-35/14, Plot No.:454, Vivekananda Nagar, Kukatpally, Hyd - 072

Phone: +91-40 - 23065133, Fax No: +91-40-23064121, Cell:+91-9705922256

Email : marketing@siriussolarenergy.com, Web Site: www.siriussolarenergy.com